



U.S. MAGNET
DEVELOPMENT
PROGRAM

Preliminary Results of the HTS/LTS Hybrid Dipole Test

MDP Video meeting on February 19, 2020

Ramesh Gupta
For Superconducting Magnet Division
Brookhaven National Laboratory

Contributions from

Work presented here and the work being performed now is thanks to many individuals, including:

Bill Sampson, Shresht Joshi, Anis Ben Yahia, Piyush Joshi, Bill McKeon, Sonny Dimaiuta, Denny Sullivan, Peter Galioto, Pat Doutney, Mike Anerella, John Cozzolino, Ray Ceruti, ...

Fixture inside the magnet

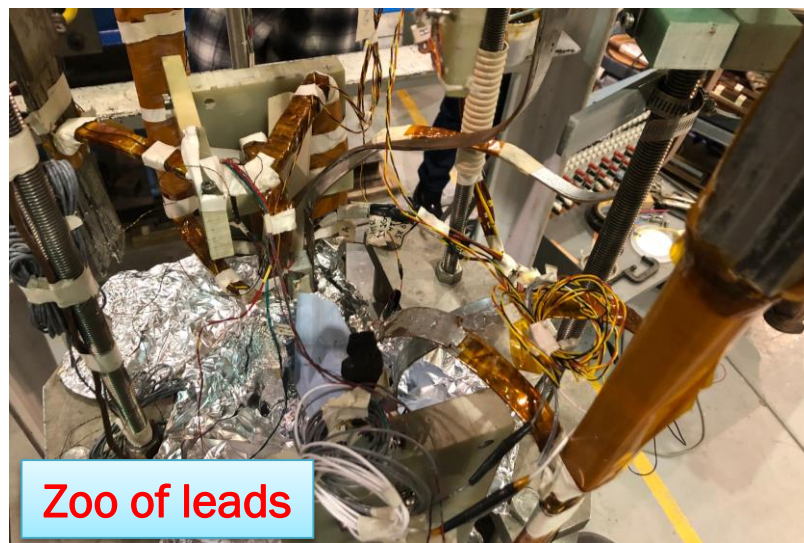
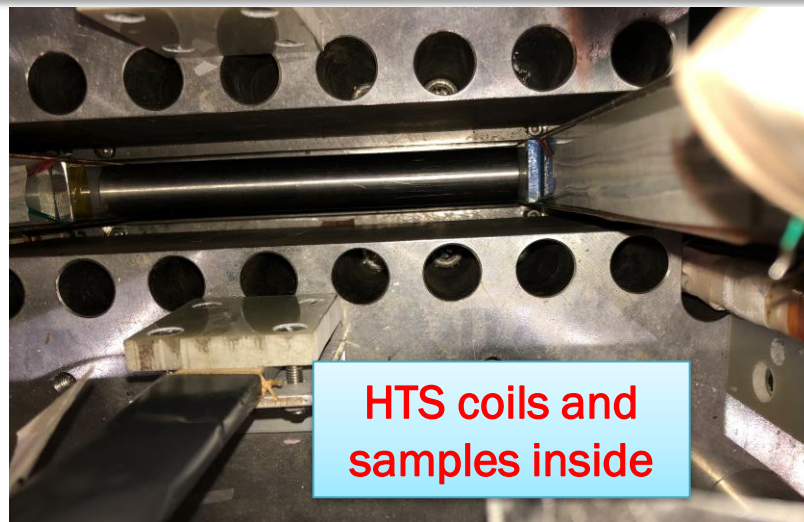
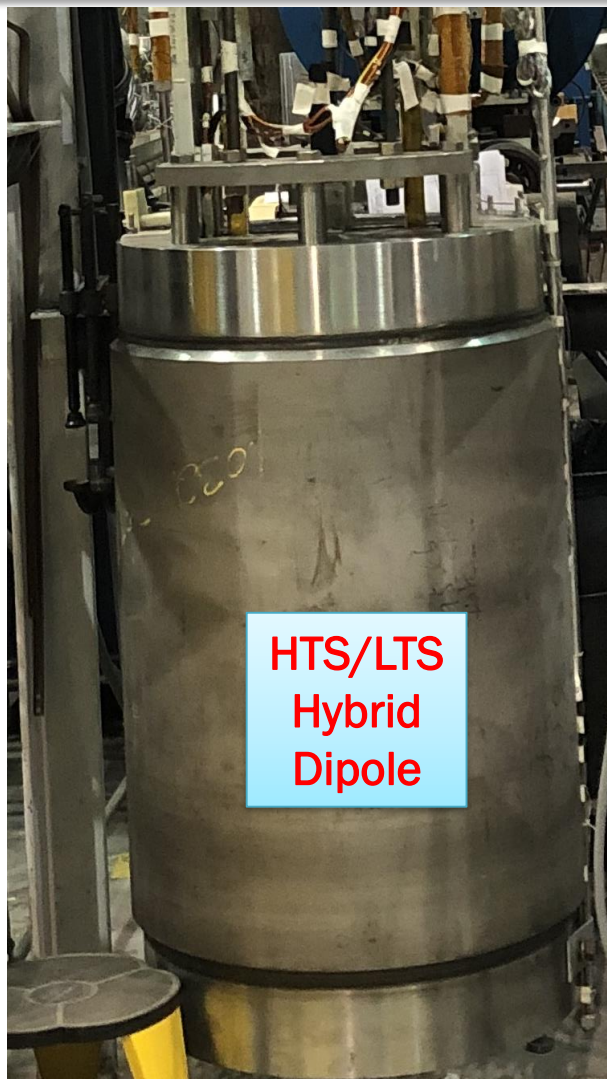

(almost everything planned in this slide done,
perhaps not always be in the order planned)

Magnetization Studies Test Program at 4.5 K.

Purpose: To perform magnetization studies of HTS coils first by themselves and then in the background field of the Nb₃Sn common coil magnet.

During the following tests the magnet field should be measured continuously by the Hall probes and recorded.

1. **HTS Nomex Coil Only** (difference voltage between two HTS pancake coils must remain < 2 mV and attempt should be made that the HTS coil doesn't quench)
 - Ramp up to 100 A and down to 0 A
 - Ramp up to 200 A and down to 0 A
 - Ramp up to 400 A and down to 0 A
 - Ramp up to 600 A and down to 0 A
 - Ramp up to 800 A and down to 0 A
2. **HTS No-Insulation Coil Only** (difference voltage between two HTS pancake coils must remain < 10 mV and attempt should be made that the HTS coil doesn't quench)
 - Ramp up to 100 A and down to 0 A
 - Ramp up to 400 A and down to 0 A
 - Ramp up to 800 A and down to 0 A
 - After review of results of above tests, make plan to ramp to higher currents
3. **LTS (Nb₃Sn) Coil Only**
 - Ramp gradually in steps to 10000 A (no quench at 10000 A in 2017 test and it reached 10,800 A in 2006).
 - If magnet trains, we will stop at 5 quenches and limit further operation of the LTS magnet to 90% of the current reached at the 5th quench.
 - If the magnet reaches 10000 A without quench, ramp the magnet to quench and limit further operation of the LTS magnet to 90% of the current reached.
4. **HTS/LTS Hybrid Magnetization Tests**
 - Hold LTS magnet at 500 A, 1 kA, 2 kA, 4 kA, 6 kA, and 8 kA, and for each HTS coil ramp up and down to whatever current safely possible without quenching (800 A nominal max).
 - Reduce current in LTS magnet and perform above steps.



Test Run at 4 K in HTS/LTS Hybrid Dipole (~2 T background field from Nb₃Sn coils)

Additional field from the HTS coils in up and down ramp (offset to start from zero to start up-ramp)

Field perpendicular (2016 SBIR)

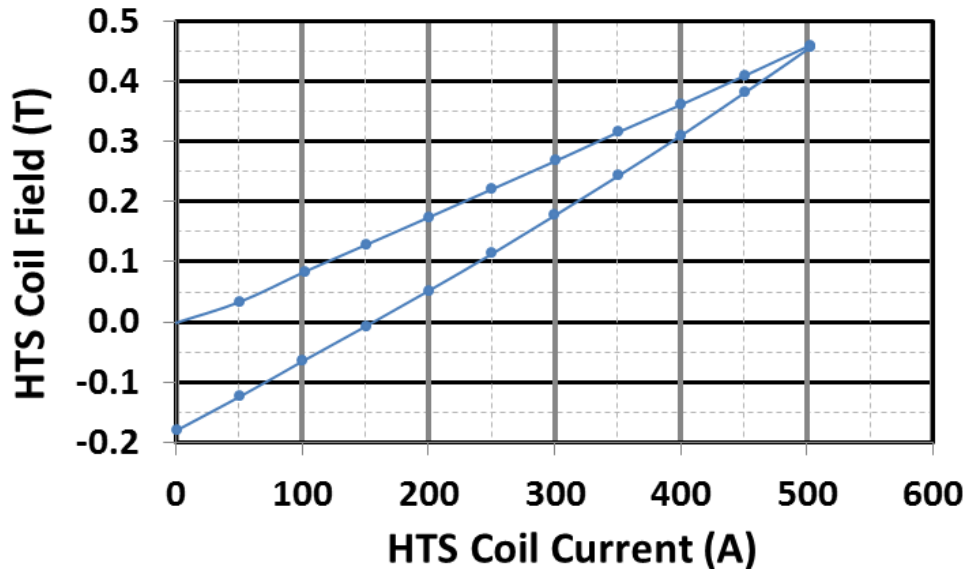

Significant reduction in magnetization from HTS coils when field is primarily parallel to the wide face when compared to primarily perpendicular

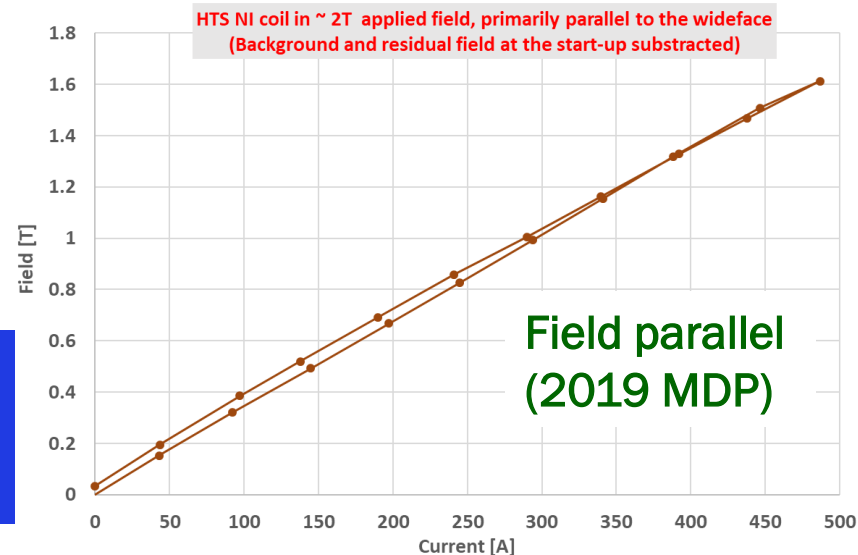
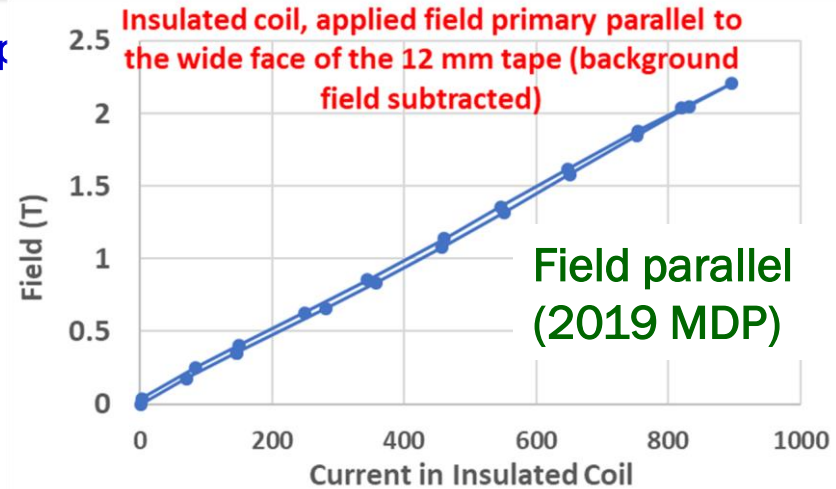

4 K run – No background field

4K magnetization - No background field

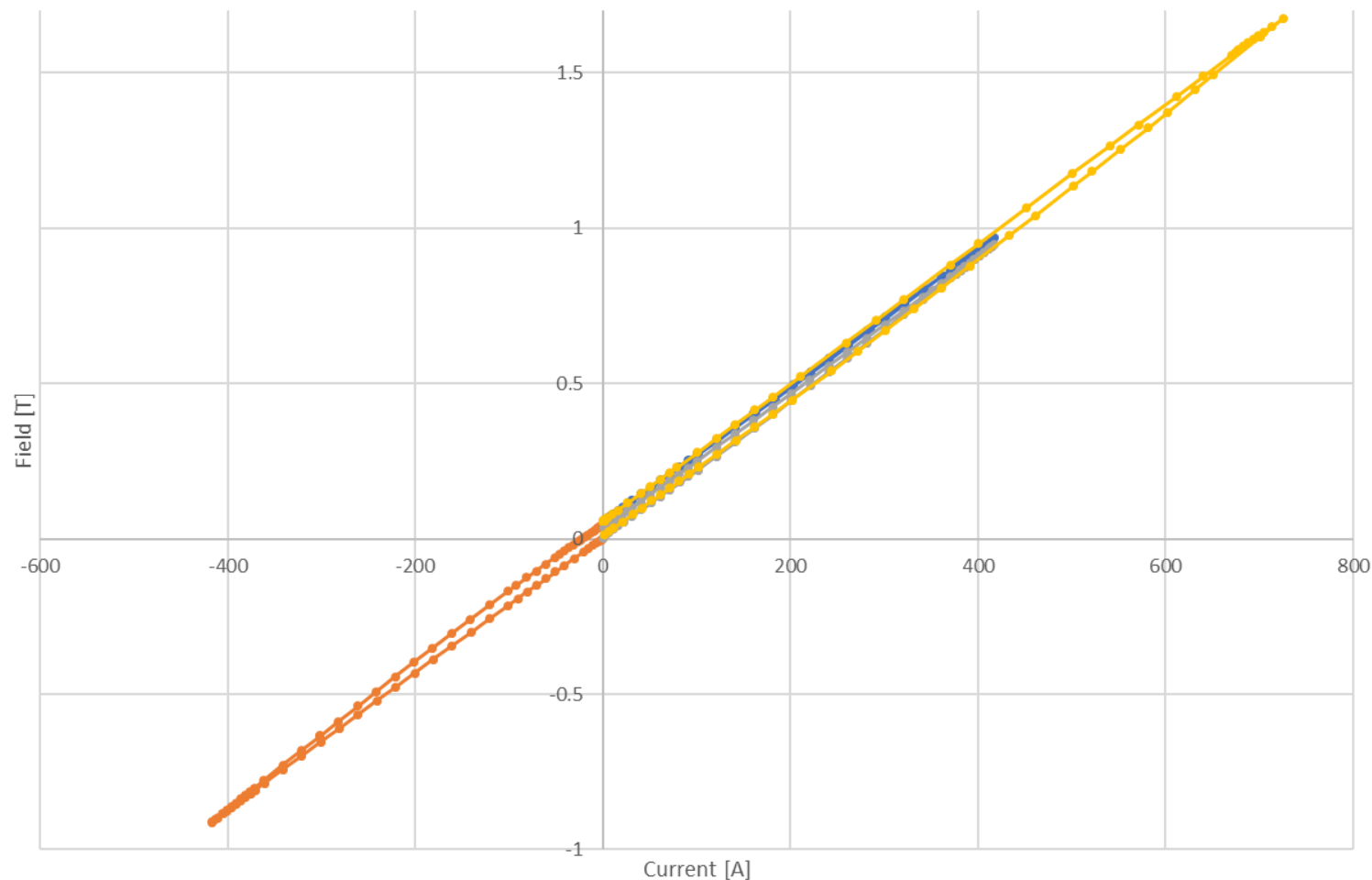

Magnetization measurement were done prior to this test up current up to 500A at higher temperatures

- 2nd 0-417A-0
- 3rd 0-417A-0 reverse polarity
- 4th 0-417A-0
- 1st 0-726A-0

4 K Magnetization Run in Background Field (background field subtracted)

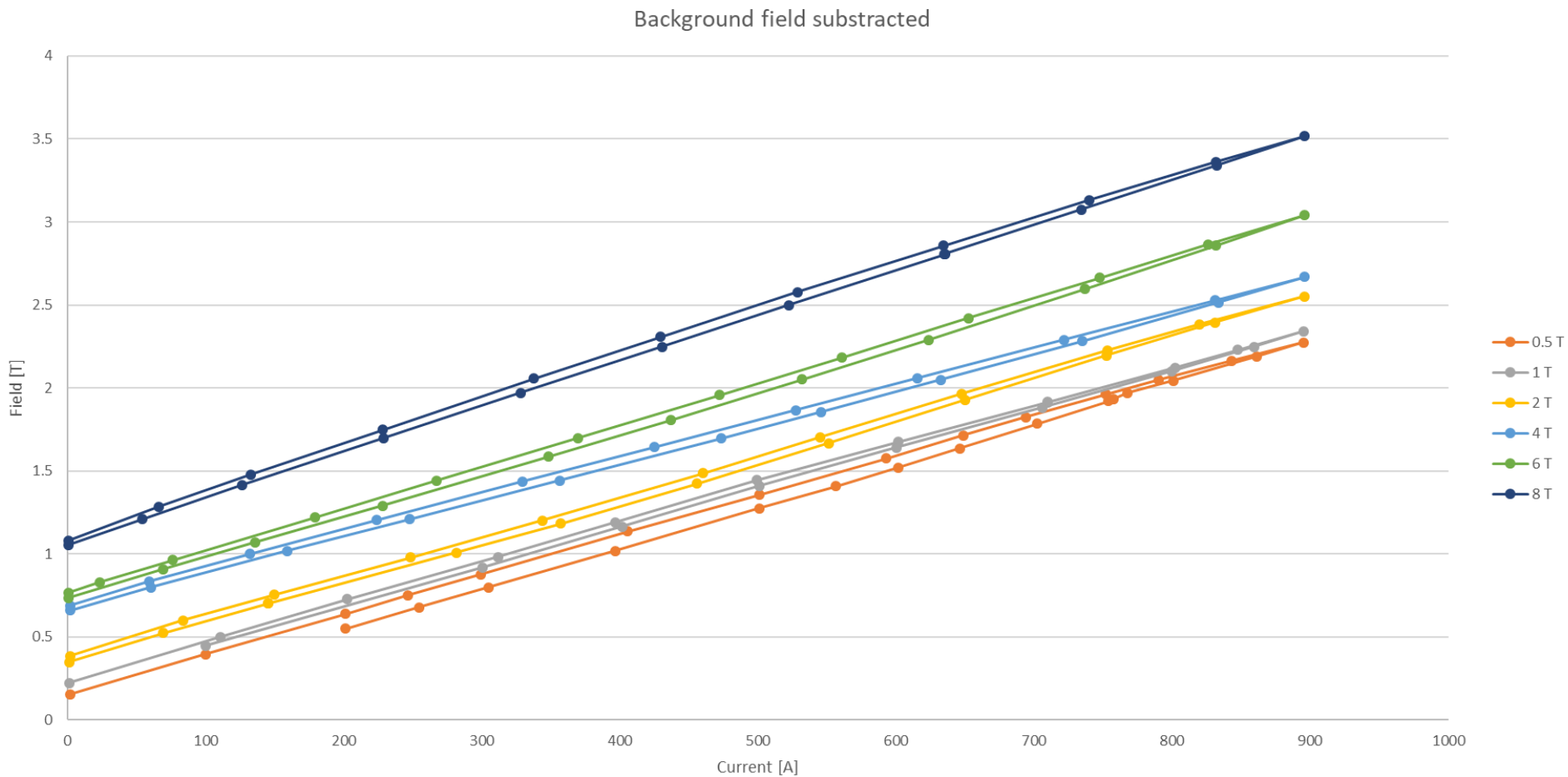



U.S. MAGNET
DEVELOPMENT
PROGRAM

Click to edit Master title style

Quench Protection of HTS/LTS Hybrid Dipole

Cutout View for Nb₃Sn coils at 10 kA and HTS coils at 1 kA (with Nomex insulation and No-insulation)

13.9 T

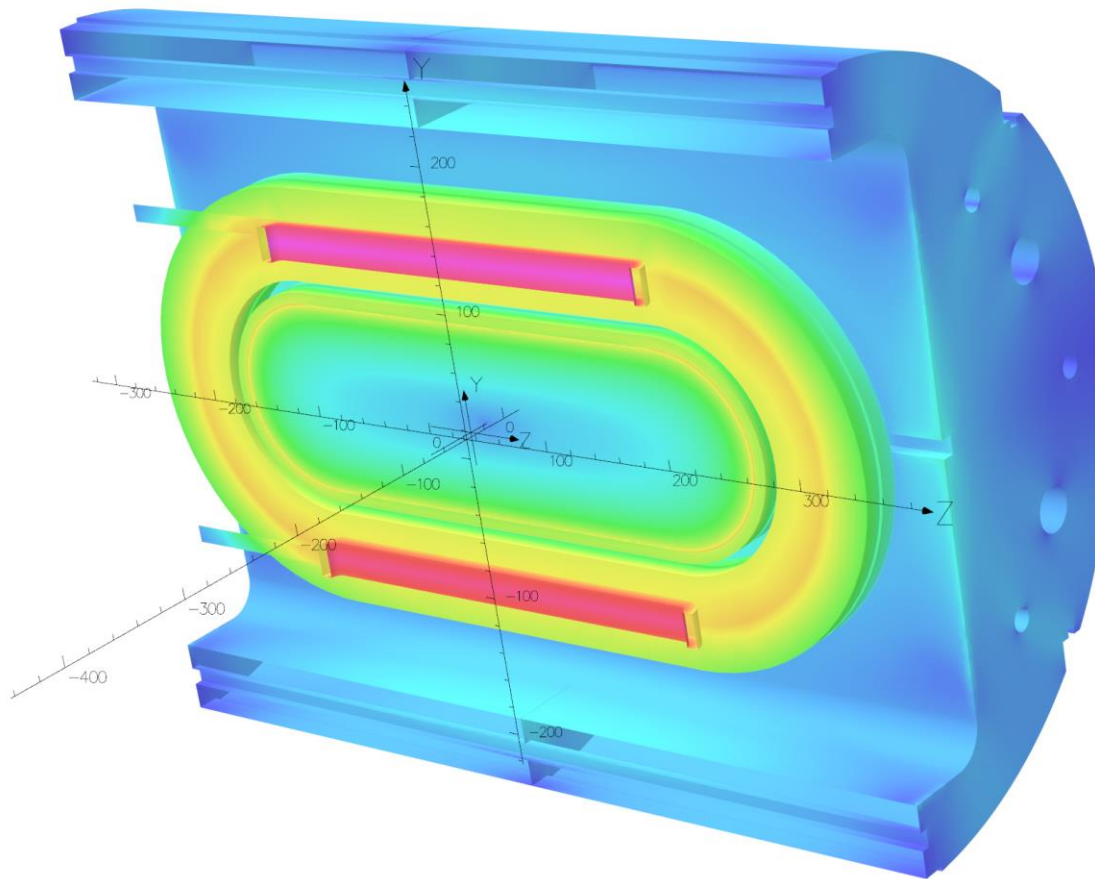

UNITS	
Length	mm
Magn Flux Density	T
Magnetic Field	A/m
Magn Scale	Per A
Current Density	A/mm ²
Power	W
Force	N

MODEL DATA	
Model	d:\017\Nb3Sn-10kA-1E\USA-nomex-10kA-simdp-jan2020.op3
Magnetostatic (TOSCA)	
Nonlinear materials	
Simulation No	1 of 1
1179508 Elements	
1151015 Nodes	
14 Conductors	
Nodes Interpolated fields	
Activated in global coordinates	
Reflection in XZ plane (Z field=0)	
Reflection in YZ plane (X field=0)	

Field Point Local Coordinates	
Local	= Global

FIELD EVALUATIONS	
Line	LINE (total) #11
	Cartesian
x	=0.0
y	=-118.0
z	=-300.0 to 300.0

HTS coils are installed with as low clearances. Horizontal Lorentz forces brings them in contact with the LTS coils



ANSYS Run Transverse Stress and Strain from Nb₃Sn 10 kA, HTS 1 kA

LTS Coils

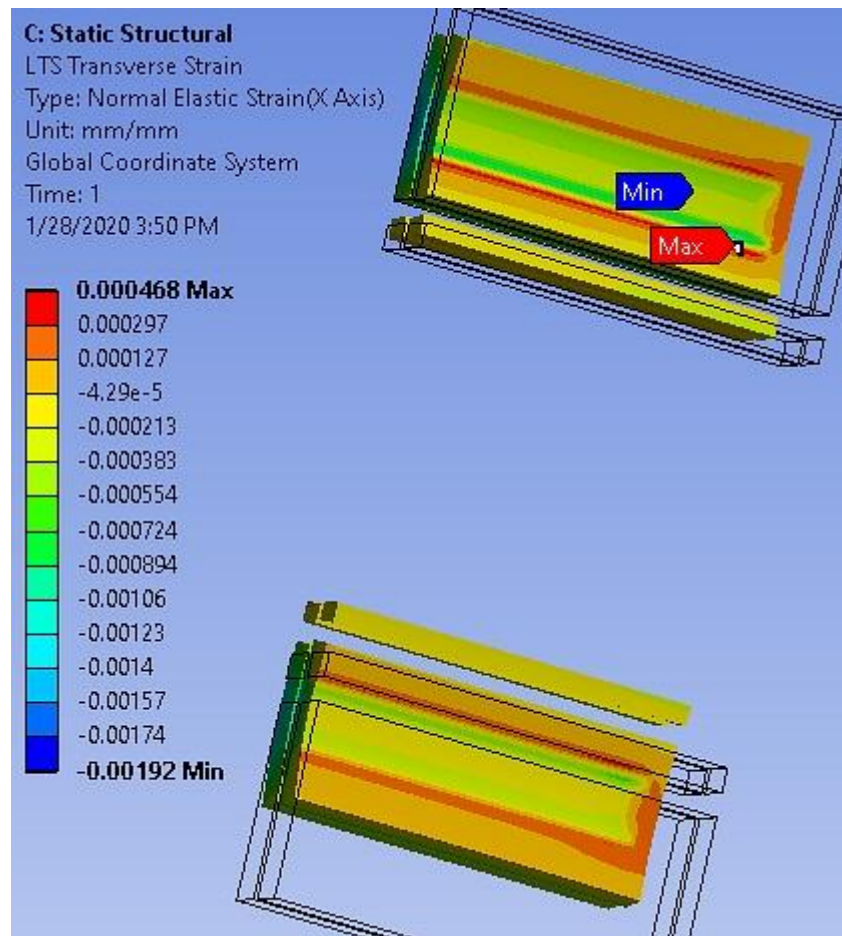
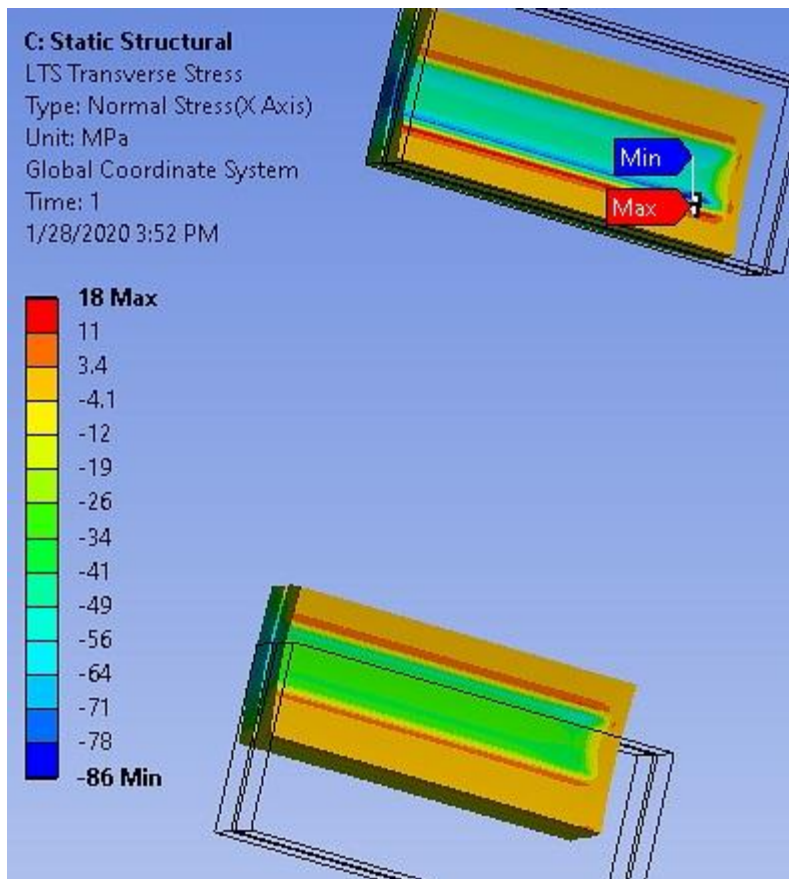

Insulated Coil Powered with the common coil (field in NI coil: Nb₃Sn field + trapped field)

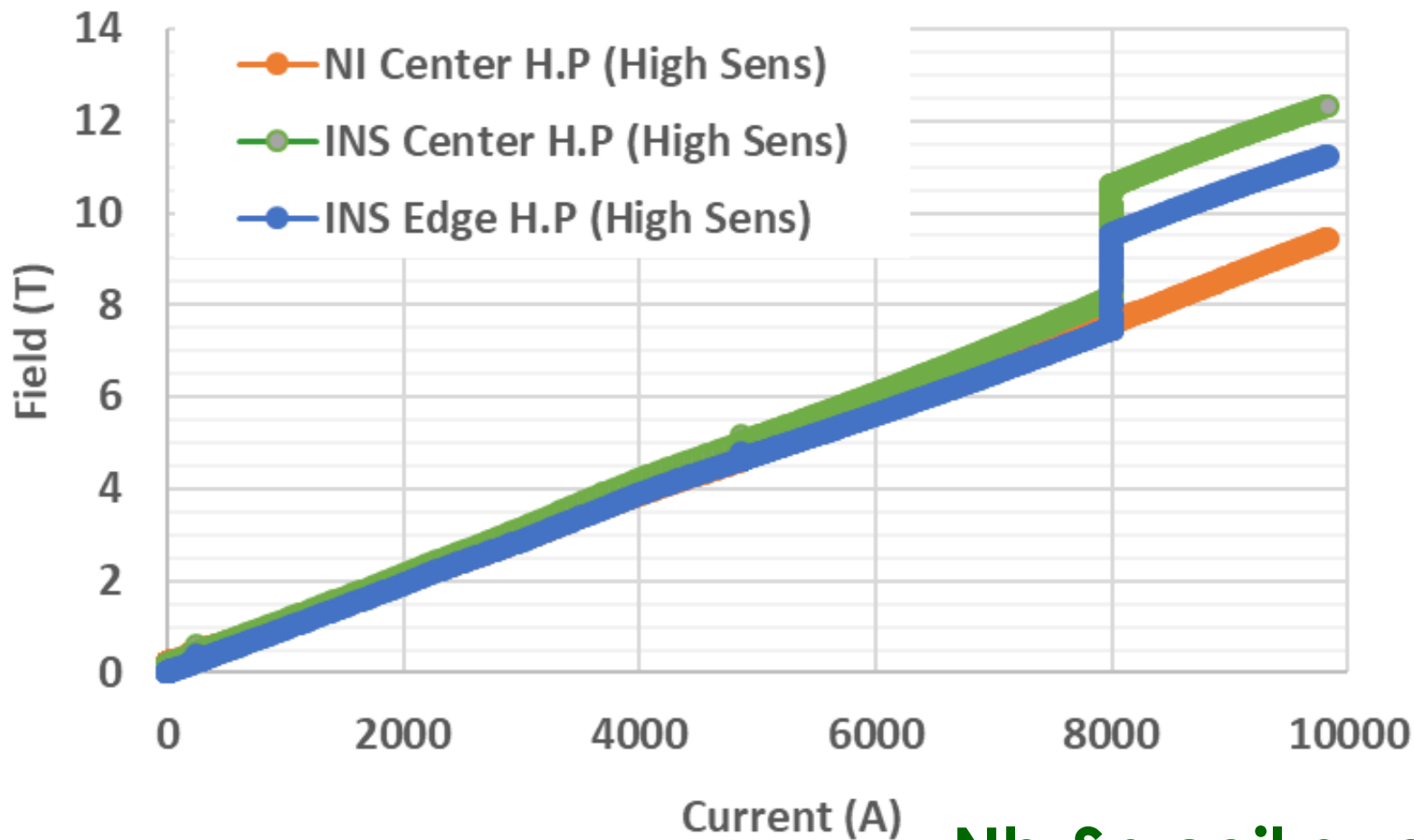

Nb₃Sn coil quenched

HTS Coil was ramped to the maximum of PS after the quench to check damage from the quench

Nb₃Sn coil quenched

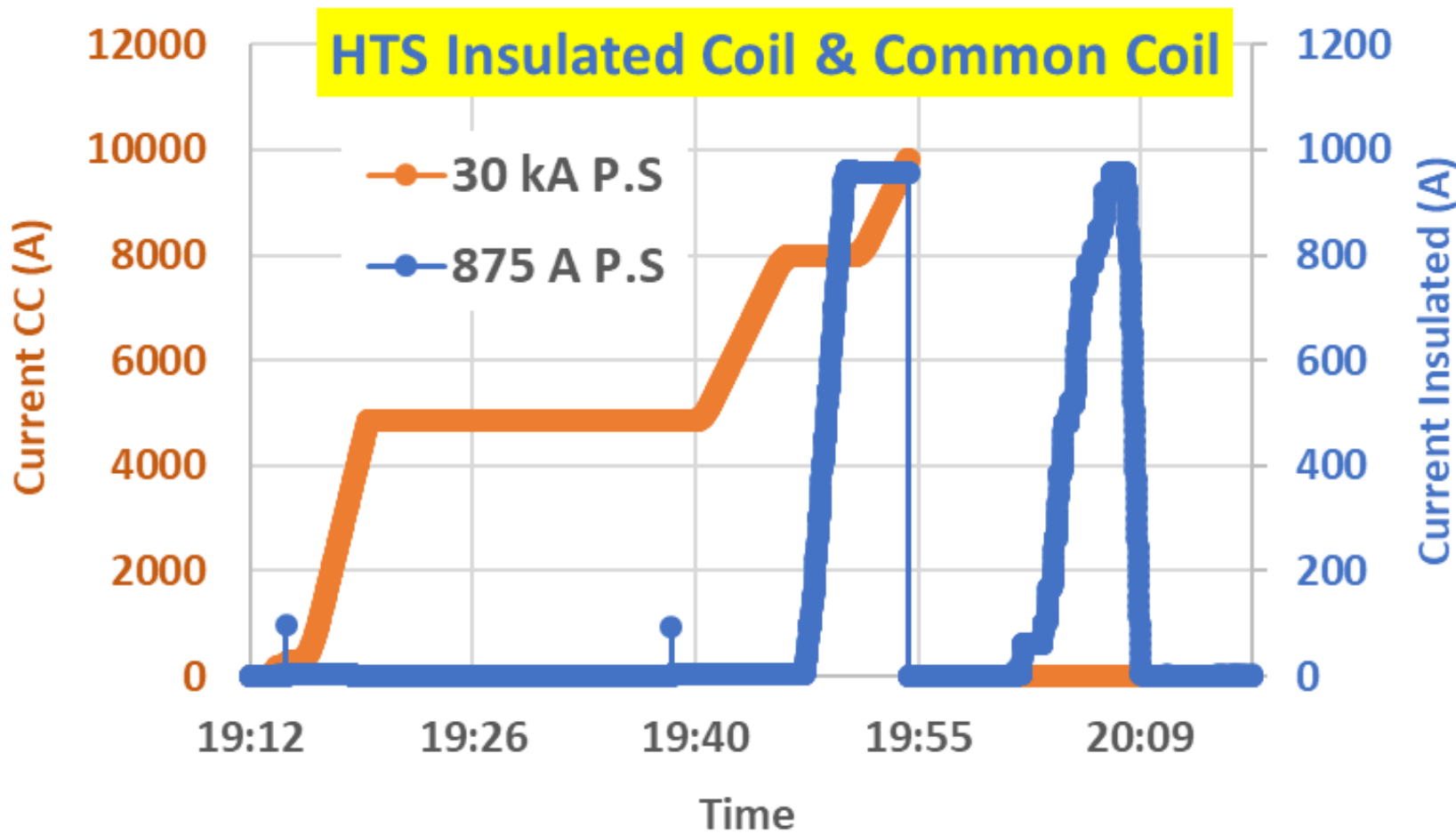

Field and Current Decay (coupling studies)

Field Decay
(quench @ t=0)

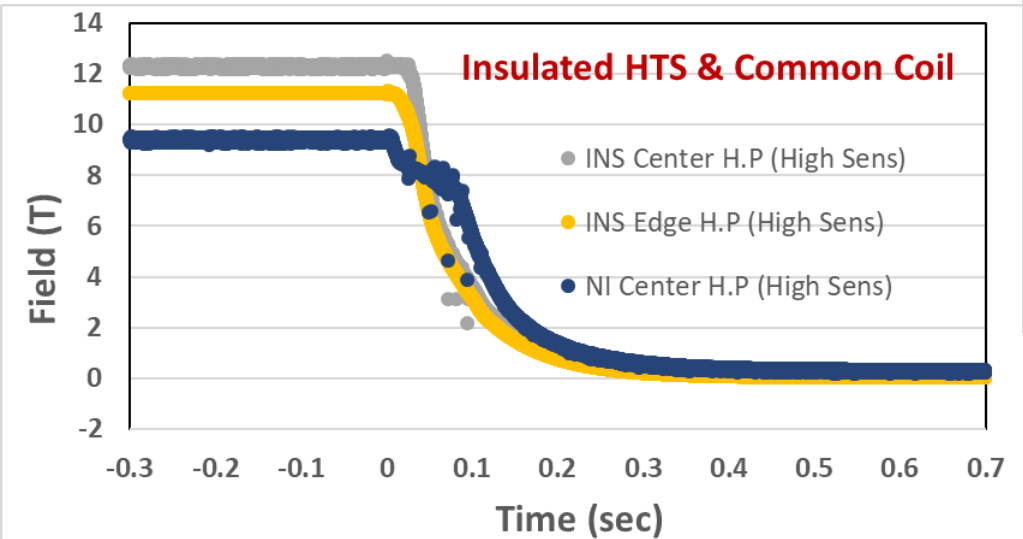

Current Decay

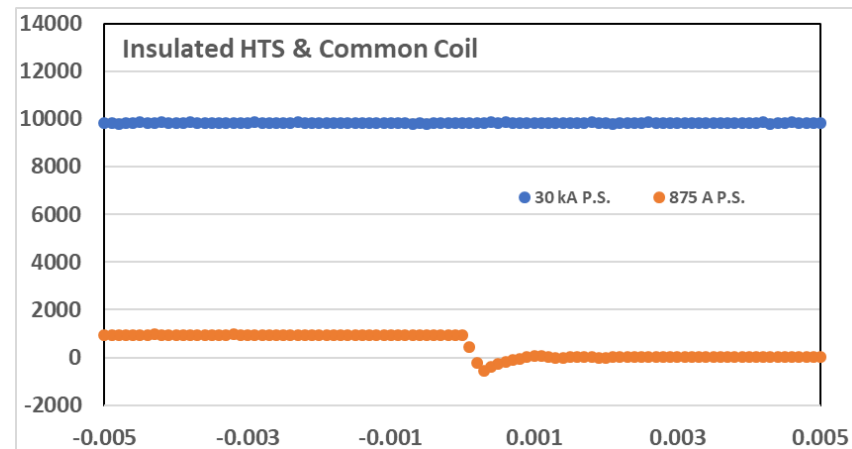
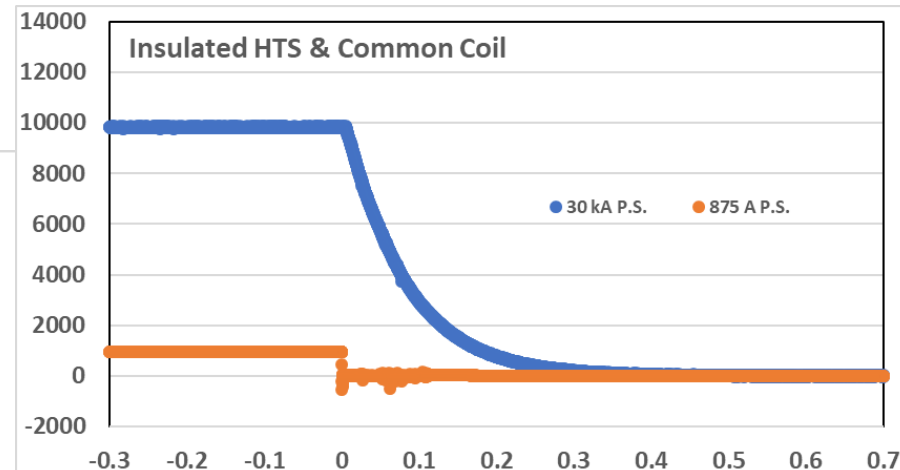

DATE	TIME	HTS COIL	Nb3Sn Coil (A)	HTS Coil (A)	B, hybrid (T)	B, Nb3Sn + trapped
13-Feb-20	1955	Nomex	9830	955	12.3 Tesla	9.39 Tesla
14-Feb-20	1157	Nomex	9617	955	11.96 Tesla	9.87 Tesla
14-Feb-20	1652	NI	10120	955	12.09 Tesla	10.37 Tesla
15-Feb-20	1318	NI	9171	1000	11.53 Tesla	9.34 Tesla
15-Feb-20	1336	NI	-	1590	4.23 Tesla	0.27 Tesla
15-Feb-20	1414	NI	8000	1110	10.74 Tesla	8.1 Tesla
15-Feb-20	1502	NI	9000	910	11.23 Tesla	9.2 Tesla

All quenches in LTS coils.

HTS coils seems to tolerate quenches from Nb3Sn coils (large energy transfer)



Extra slides

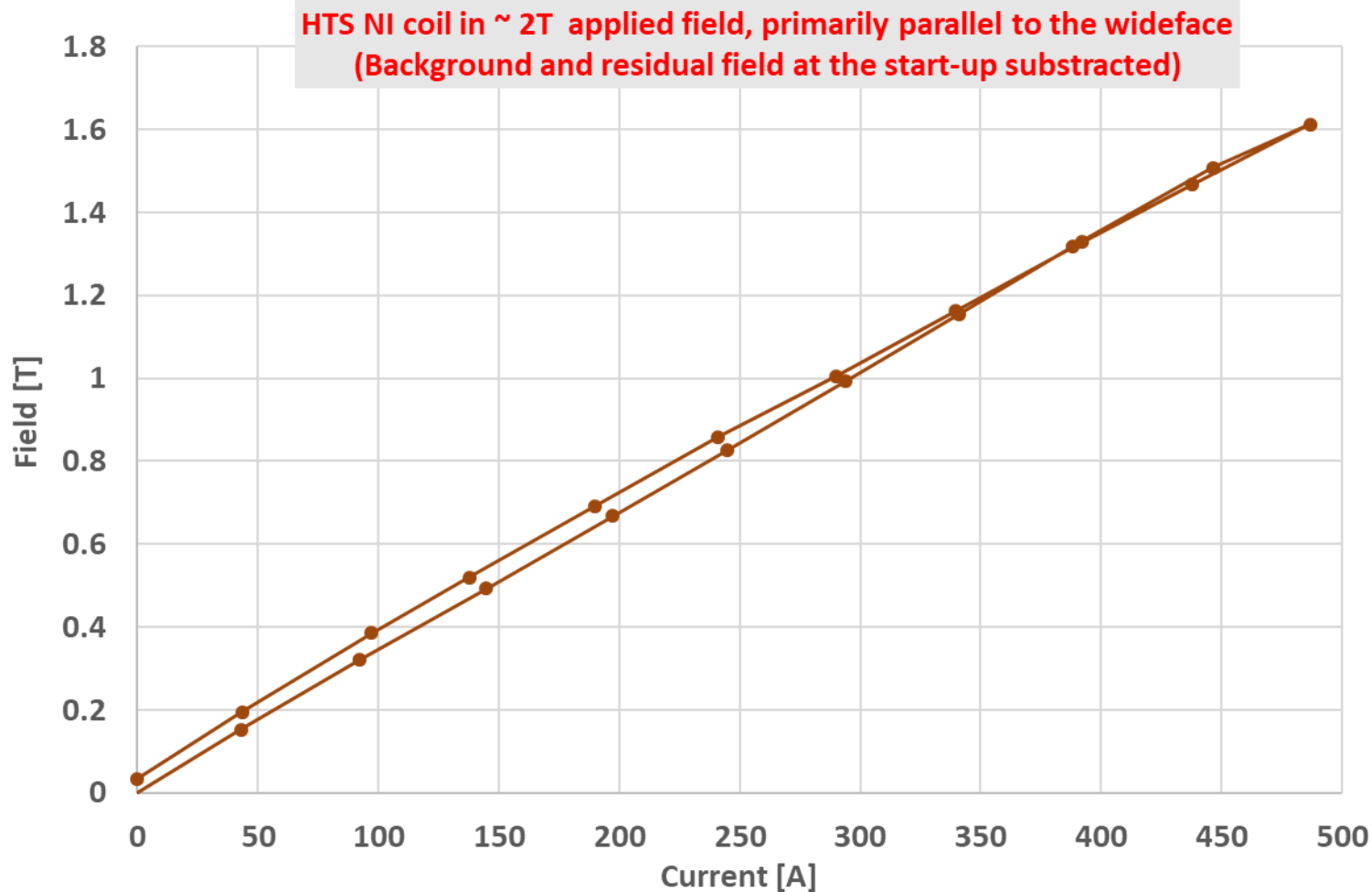



HTS Coil in 2 T Field (primarily parallel to the wide face) **INSULATED COIL**

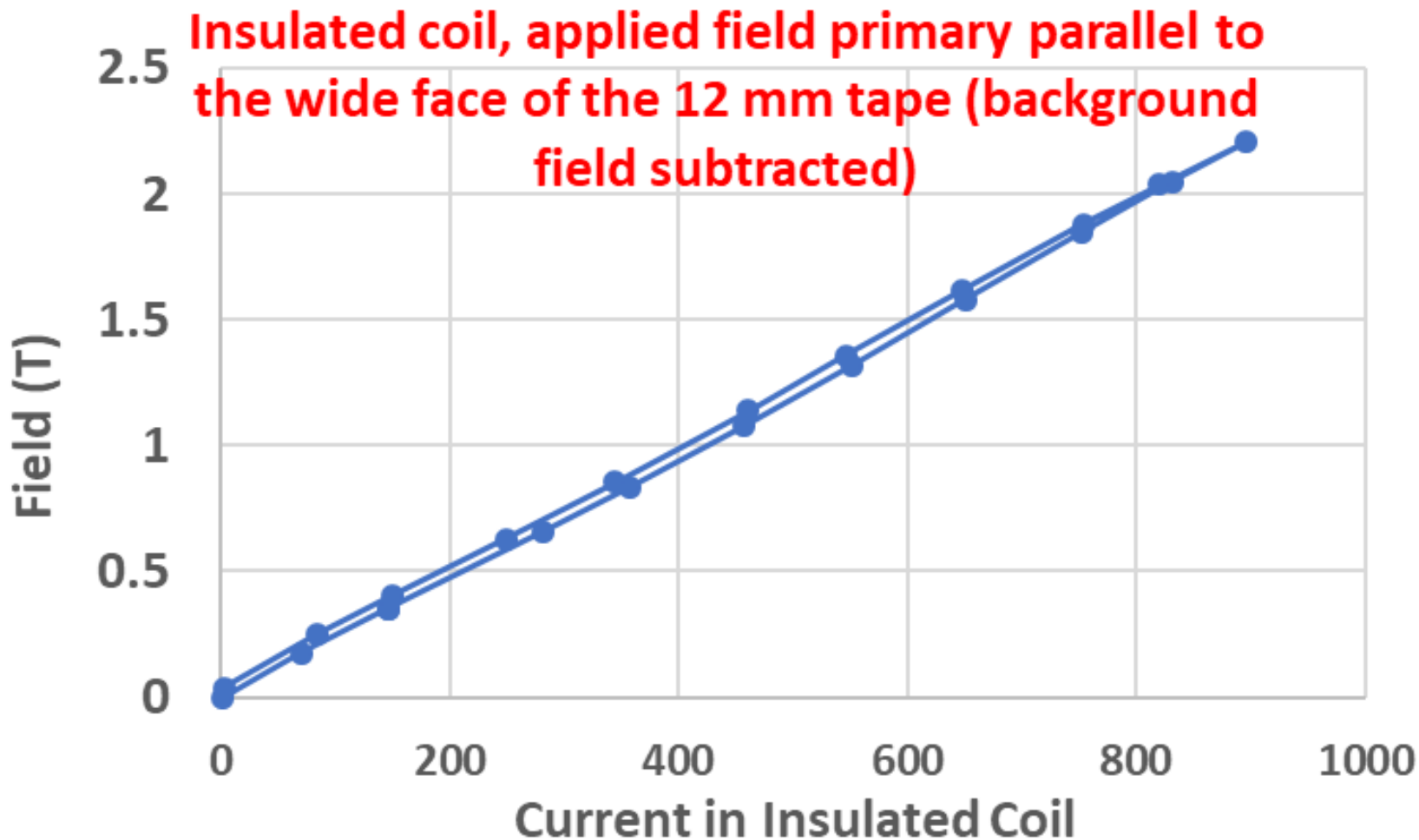



2016 Test (Field Perpendicular)

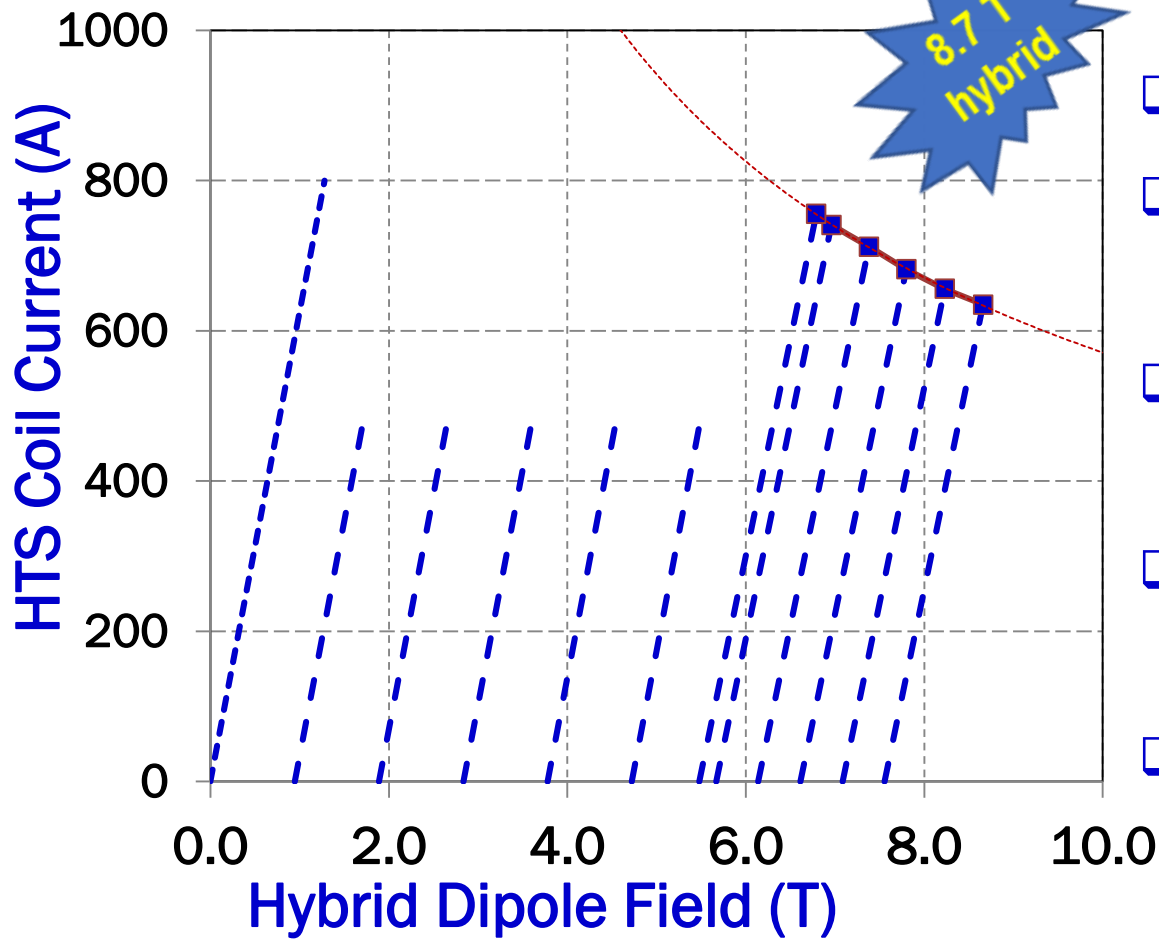

- HTS coils with ASC tape
- Field primarily perpendicular to the wide side of the tape
- HTS coils were ramped to quench, just like LTS coils
- No measurable degradation found
- Test limited by the current leads of LTS coil



Feedback of Quenching of HTS Coils on LTS Coils in HTS/LTS Hybrid Magnet (2016)

Coupling between the HTS & LTS coils

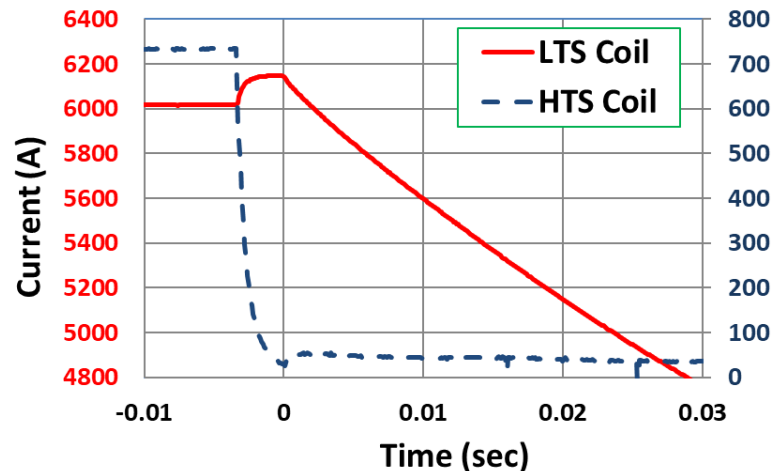
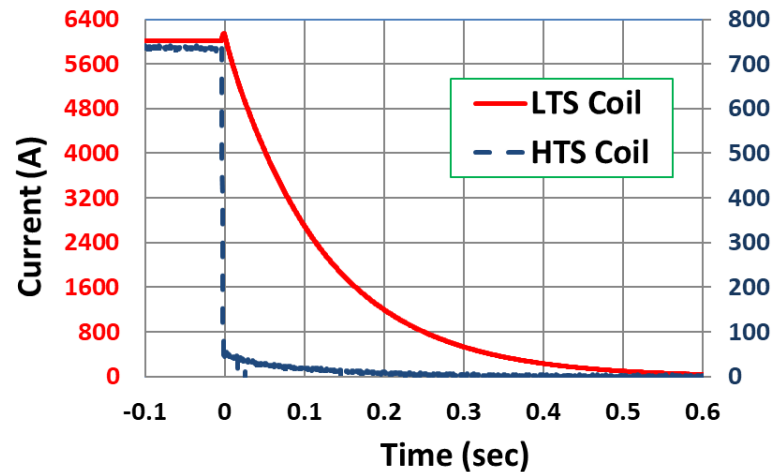
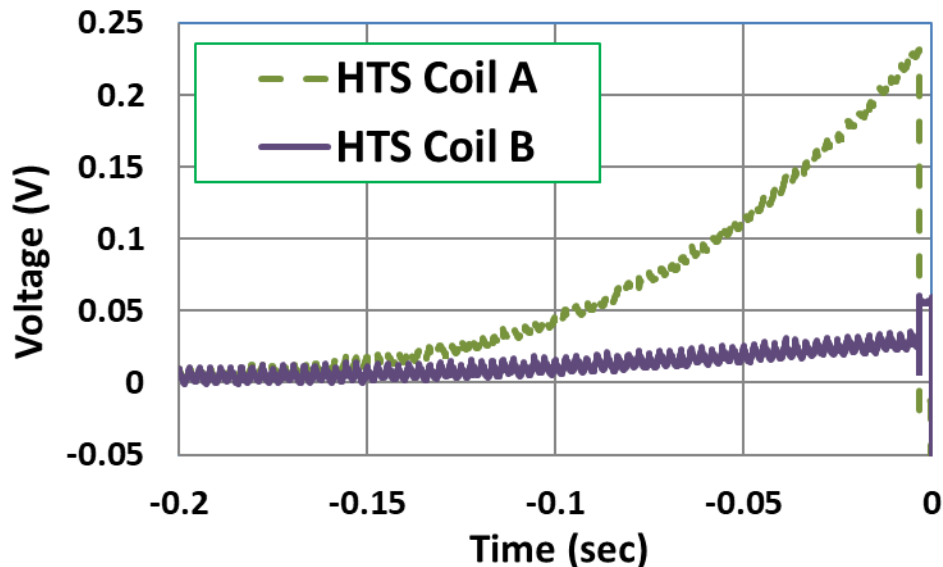

What happens to HTS coils
if LTS coil quench?